

Road stud

MK R0/60D with shank white

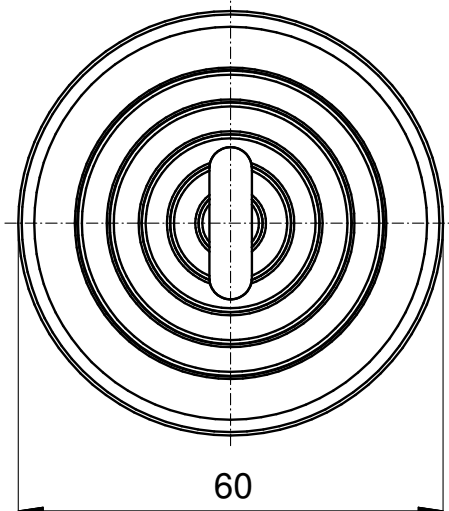
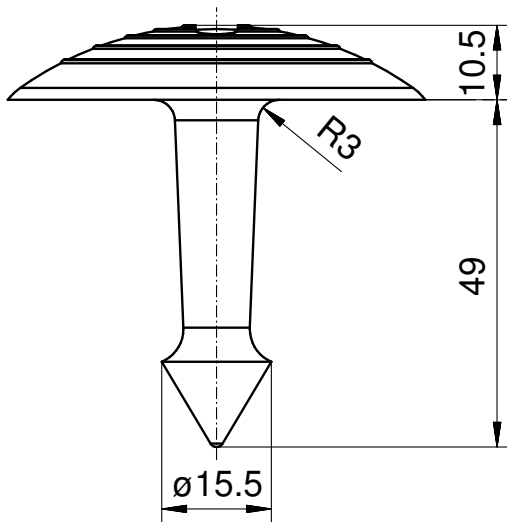

REFLECTOR DATA

Application	Plastic road stud
Item	MK R0/60D with shank white
Item no.	81732100

TECHNICAL SPECIFICATIONS

Shape	round
Size(ØxHeight)	60 x 10,5 mm
Tolerance	TG5 [DIN 16742]
Mounting	To be glued (without tape) To be pressed in
Chemical resistance	Standard
Operating temp.	-20°C bis +70°C
Surface	Standard

MATERIAL DATA

Material bracket	PE white
Material reflector	-

DESCRIPTION

Road studs for marking roads, traffic routes and parking spaces