

Road stud
MK R4/120D 2 Bo. yellow

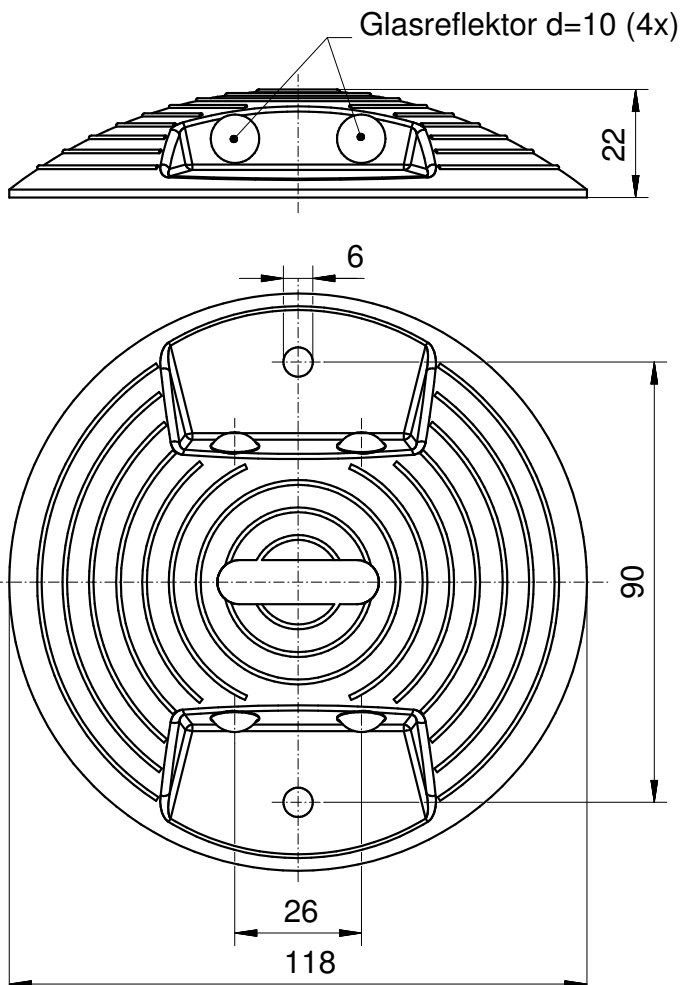

REFLECTOR DATA

| | |
|-------------|-------------------------|
| Application | Plastic road stud |
| Item | MK R4/120D 2 Bo. yellow |
| Item no. | 19232520 |

TECHNICAL SPECIFICATIONS

| | |
|---------------------|---|
| Shape | round |
| Size(ØxHeight) | 118 x 22 mm |
| Tolerance | TG5 [DIN 16742] |
| Mounting | To be glued (without tape) To be nailed (without nail) |
| Chemical resistance | Standard |
| Operating temp. | -20°C bis +70°C |
| Surface | Standard |

MATERIAL DATA

| | |
|--------------------|-------------|
| Material bracket | PE yellow |
| Material reflector | Glas yellow |

DESCRIPTION

Road studs for marking roads, traffic routes and parking spaces