

Road stud MK R4/120D white

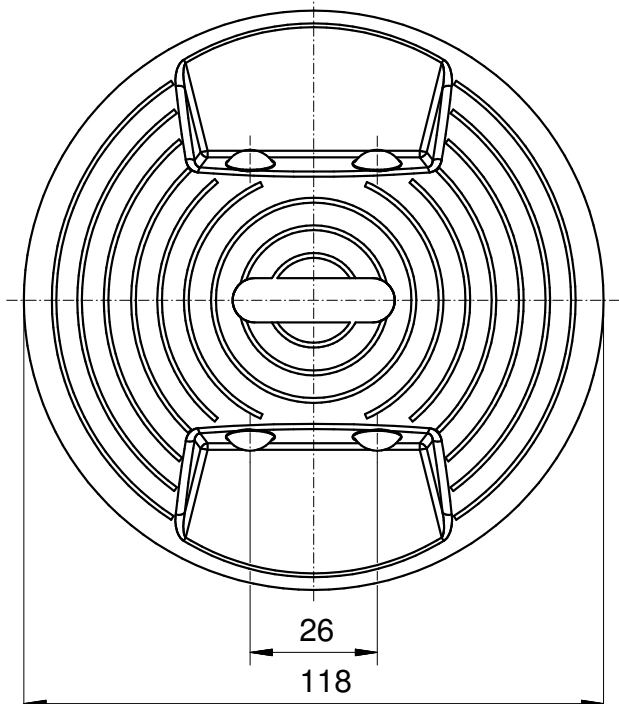
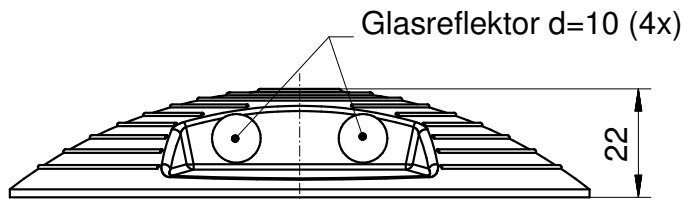

REFLECTOR DATA

Application	Plastic road stud
Item	MK R4/120D white
Item no.	81832500

TECHNICAL SPECIFICATIONS

Shape	round
Size(ØxHeight)	118 x 22 mm
Tolerance	TG5 [DIN 16742]
Mounting	To be glued (without tape)
Chemical resistance	Standard
Operating temp.	-20°C bis +70°C
Surface	Standard

MATERIAL DATA

Material bracket	PE white
Material reflector	Glas clear

DESCRIPTION

Road studs for marking roads, traffic routes and parking spaces